



GEEPLUS

T1L-0625-xxV

$$\text{Duty Cycle} = \frac{\text{"on" time}}{\text{"on" time} + \text{"off" time}} \times 100\% \quad 50\% \text{ ED}$$

Coil Data

Maximum "on" time in seconds	8
Watts at 20°C	5.3
Ampere-Turns at 20°C	402

P/N	Resistance ±10% @ 20°C	Coil Turns	Volts DC	Release Current
T1L-0625-6v	6.8 Ω	456	6	880 mA
T1L-0625-12v	27.0 Ω	896	12	440 mA
T1L-0625-24v	108.0 Ω	1790	24	220 mA

General Parameters

Life Expectancy (Cycles)	200,000
Mass	26 grammes
Plunger Mass	4.6 grammes
Leadwires 250mm (10")min, UL1007, AWG26	
Isolation Class	A (105°C)
Dielectric Strength 1000V AC, 50/60Hz, 1min	
Insulation Res >100MΩ, 500V DC Megger	

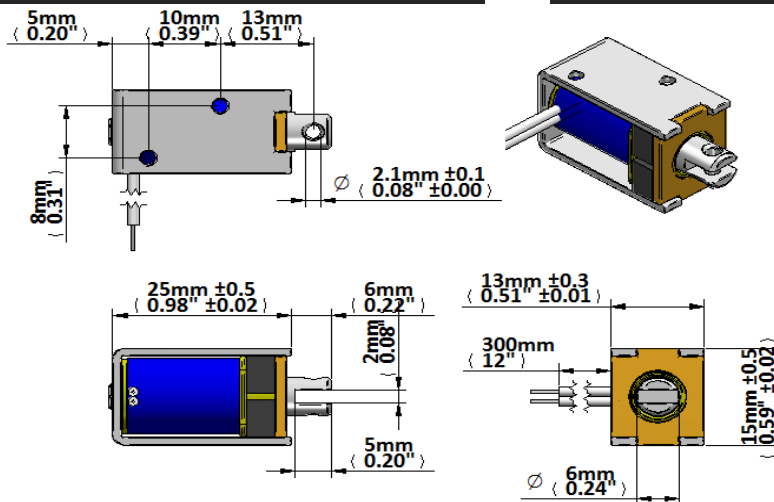

Force (N) vs Displacement (mm) & Release Characteristic

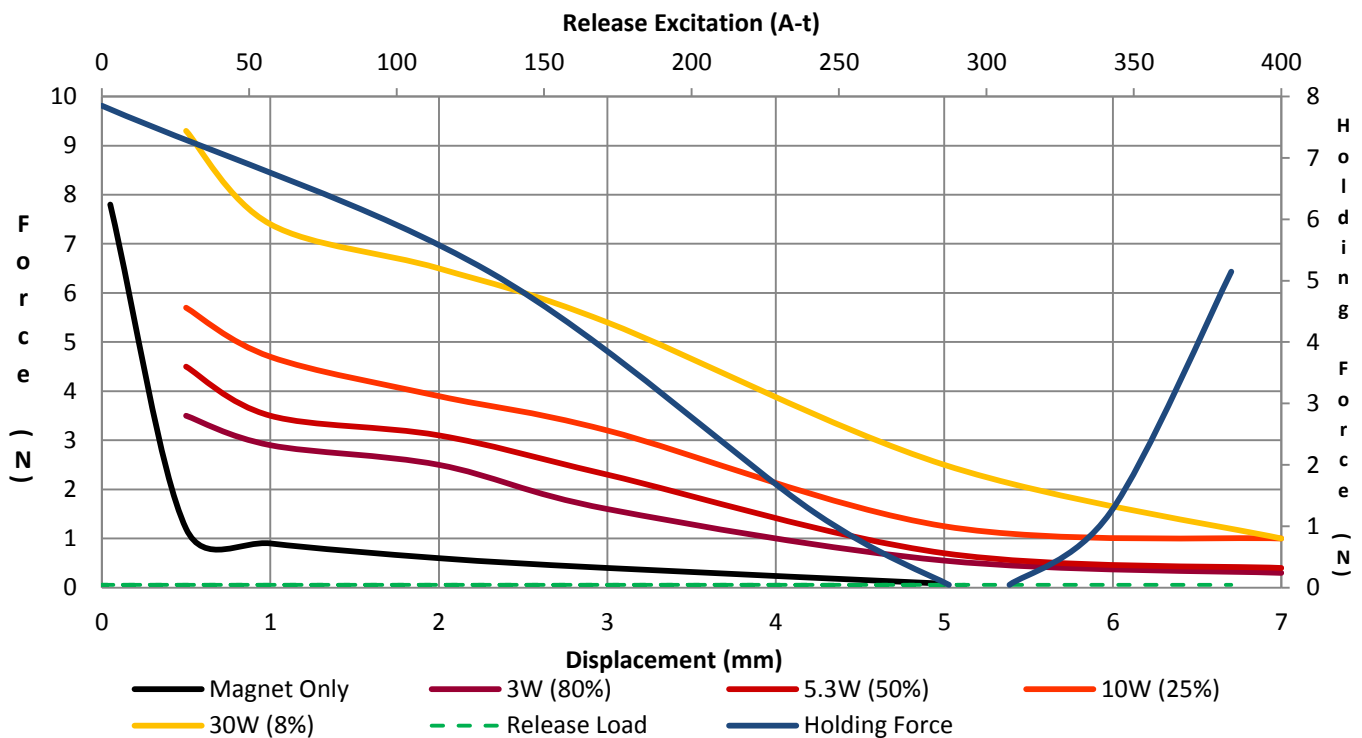

Geeplus reserves the right to change specifications without notice

www.geeplus.biz e-mail: info@geeplus.biz